

6.5" Woofer

# PURE SOUND

6mm Linear Stroke Woofer with Ultra Low Distortion

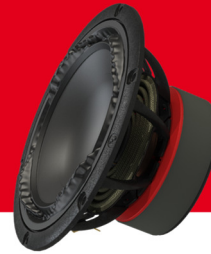

## PTT6.5W04-NFA-01 DATA SHEET

- ⊙ Negligible Force Factor Modulation and Surround Radiation Distortion
- ⊙ Low Magnetic Hysteresis Distortion
- ⊙ Best mix of volume displacement and midrange efficiency
- ⊙ Uncompromised midrange performance
- ⊙ Designed and Manufactured in Denmark

### KEY SPECIFICATIONS

Driver size	6.5"
DC resistance, $R_{DC}$	3.7 $\Omega$
Resonance freq., $f_s$	33 Hz
Total Q factor, $Q_{ts}$	0.26
Effective piston area	133 cm <sup>2</sup>
Equivalent volume, $V_{as}$	29 L
SPL@2.83V <sub>rms</sub> /1m	90.3 dB
Linear $X_{max}$	+/- 5.9 mm
Mechanical $X_{max}$	+/- 14.5 mm
IEC Power handling	250 W
Cone material	Proprietary Fibre Mix

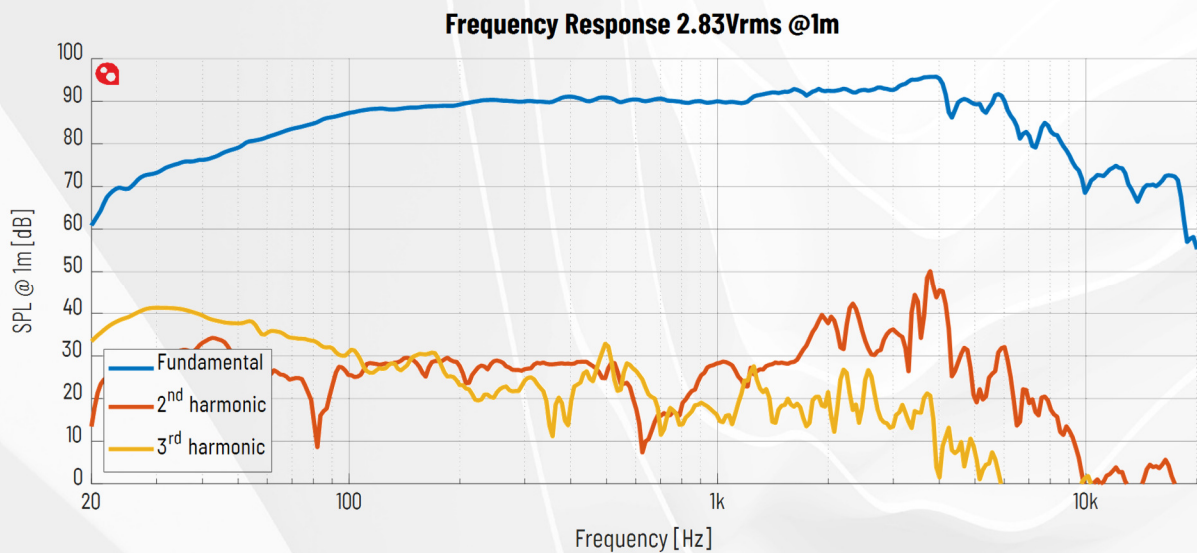

## 1 Specifications

### 1.1 Electrical & Acoustical Parameter

Parameter		Typ	Unit
$Z_n$	Nominal impedance	4	$\Omega$
$Z_{min}$	Minimum impedance above resonance	4.15	$\Omega$
$f_{min}$	Frequency for minimum impedance	310	Hz
$Z_o$	Maximum impedance	88	$\Omega$
$R_{DC}$	DC resistance	3.7	$\Omega$
$L_e$	Voice Coil inductance @ 1kHz 0mm	0.32	mH
SPL	SPL@2.83V <sub>rms</sub> /1m, 300Hz-800Hz, ref. 20 $\mu$ Pa	90.3	dB
	SPL@1W( $Z_{min}$ )/1m, 300Hz-800Hz, ref. 20 $\mu$ Pa	87.5	dB

Table 1 Electrical &amp; Acoustical Parameters

### 1.2 T/S & Lumped Parameters

Parameter		Typ	Unit
$f_s$	Resonance frequency	33	Hz
$Q_{ms}$	Mechanical Q factor	6.3	-
$Q_{es}$	Electrical Q factor	0.27	-
$Q_{ts}$	Total Q factor	0.26	-
$V_{as}$	Equivalent volume	28.9	L
$S_d$	Effective piston area	132.7	cm <sup>2</sup>
$D$	Effective piston diameter	13.0	cm
$Bl$	Force factor	7.7	N/A
$R_{ms}$	Mechanical resistance	0.7	kg/s
$M_{ms}$	Moving mass	21.1	g
$C_{ms}$	Suspension compliance	1.10	mm/N

Table 2 T/S &amp; Lumped Parameters

### 1.3 Mechanical Properties

Parameter		Typ	Unit
<b>Excursion Properties</b>			
$X_{max}$	Linear excursion = (Voice Coil length - Airgap height) / 2	+/- 5.9	mm
	Mechanical excursion	+/- 14.5	mm
<b>Physical Dimensions</b>			
	Basket diameter	176	mm
	Cutout diameter	145	mm
	Mounting hole pattern diameter	166	mm
	Mounting hole diameter	5.1	mm
	Magnet diameter	100	mm
	Outer flange height	3.6	mm
	Build-in depth	85.2	mm
<b>Voice Coil Properties</b>			
	Voice Coil diameter	39	mm
	Voice Coil length	15.8	mm
	Voice Coil layers	4	-
	Airgap height	4	mm
	Winding material	CCAW	-

Table 3 Mechanical Properties

### 1.4 Power Handling

Parameter		Typ	Unit
	Long term maximum power (IEC268-5 18.2)	250	W
	Rated noise power, 100h (IEC268-5 18.4)	80	W

Table 4 Power Handling

### 1.5 Typical Performance, Graphs

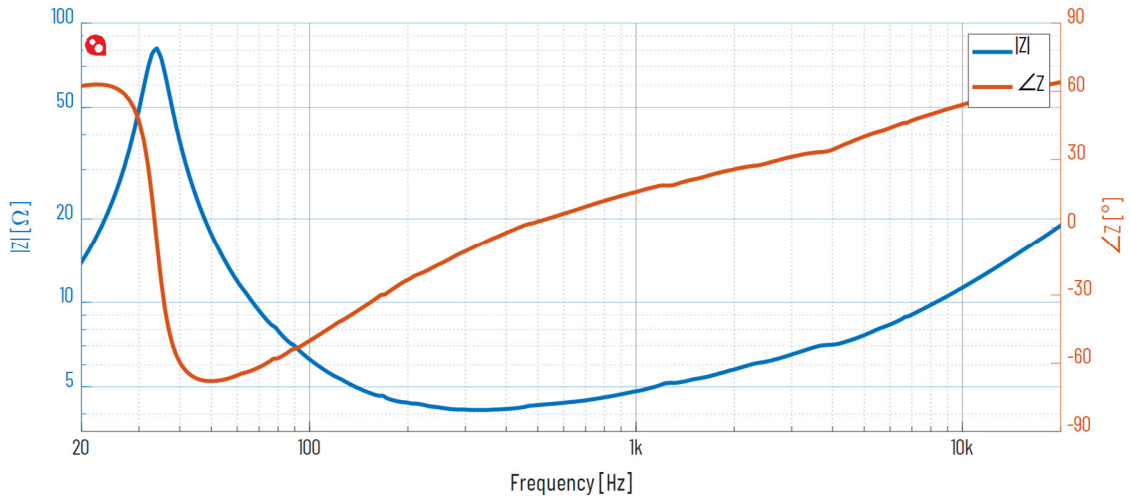

Figure 1 Impedance Response @ 2.83V

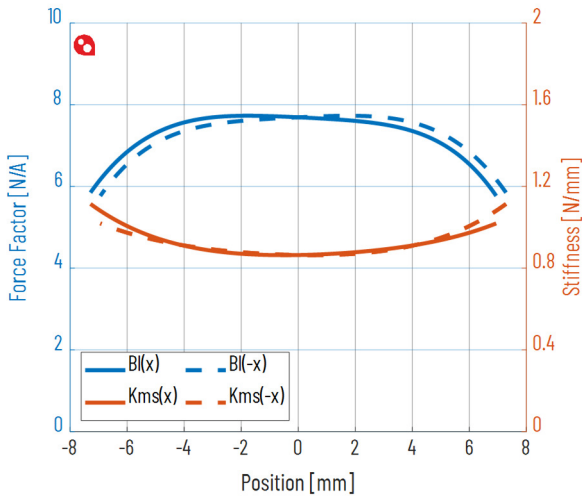

Figure 2 Force Factor and Stiffness vs Voice Coil Position

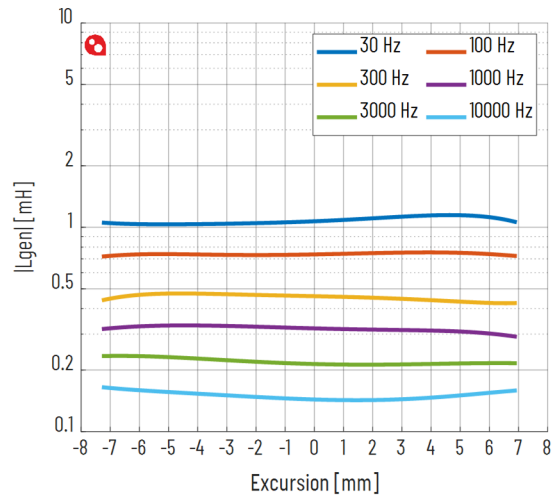

Figure 3 Inductance vs Voice Coil Position

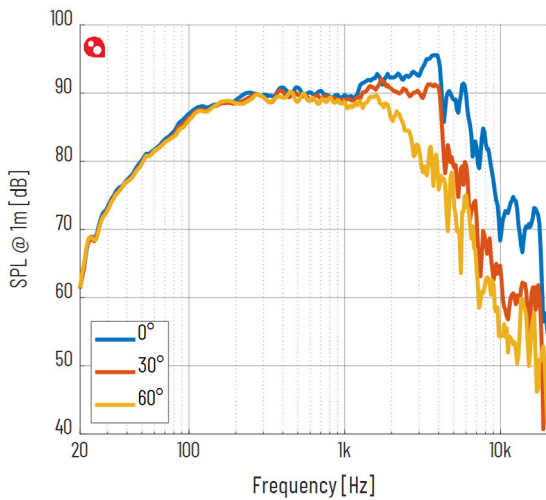

Figure 4 Axial Frequency Response @ 1m, 2.83Vrms

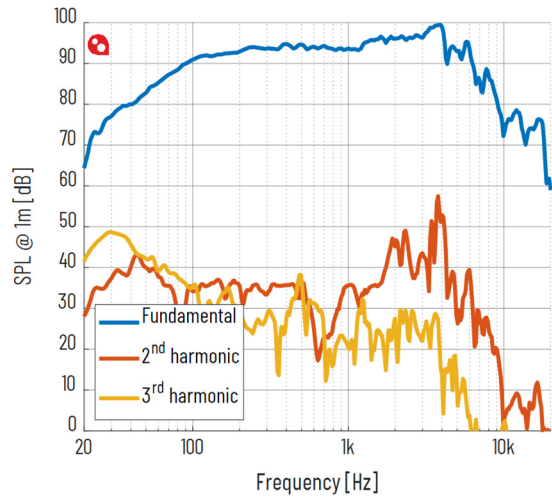

Figure 5 Frequency Response @ 1m, 94dB

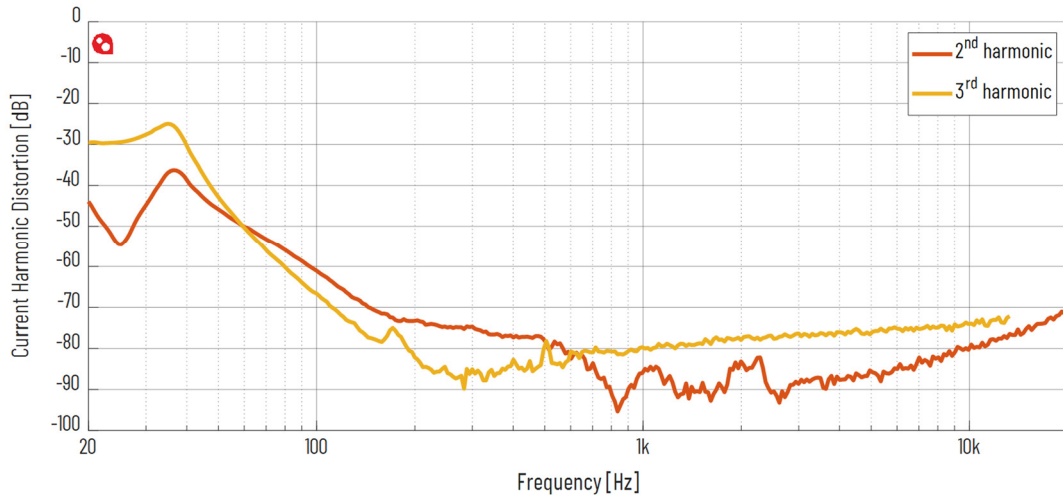

Figure 6 Current Harmonic Distortion @ 2.83Vrms

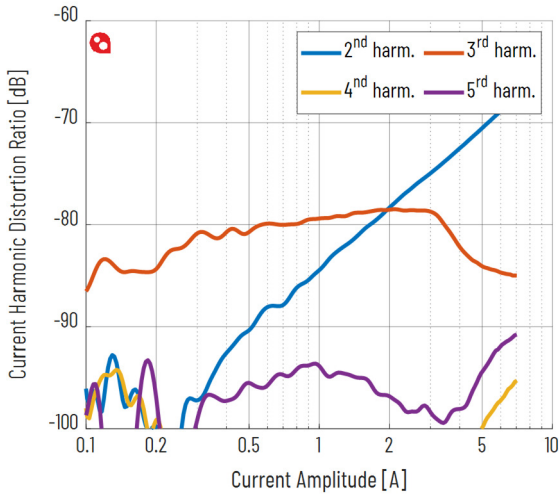

Figure 7 Current Harmonic Distortion @ 1kHz, 0-28.3Vrms

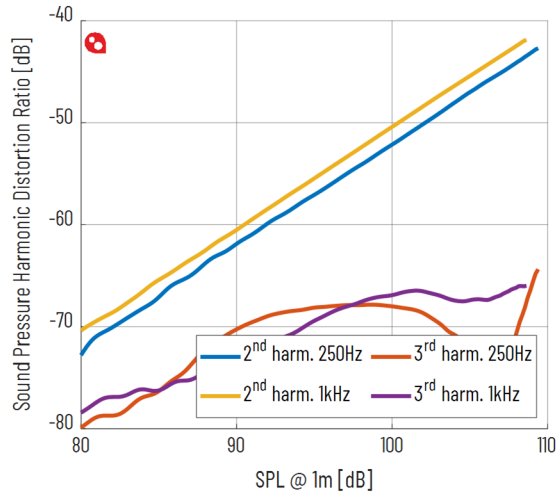

Figure 8 Sound Pressure Harmonic Distortion @ 1m, 0-28.3Vrms

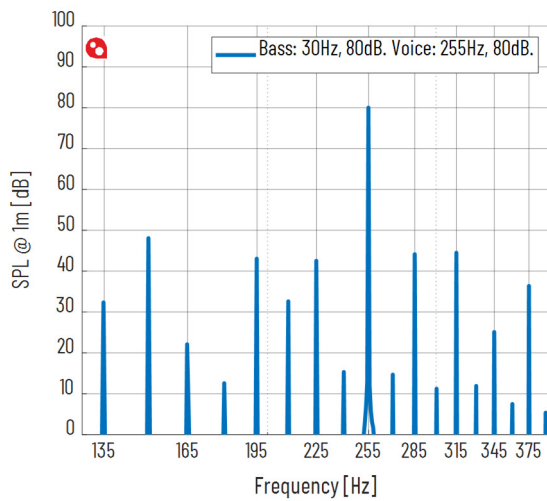

Figure 9 Intermodulation Distortion @ 30Hz 80dB, 255Hz 80dB

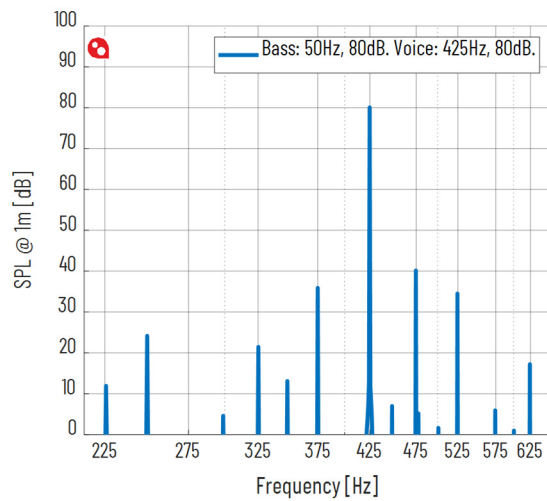
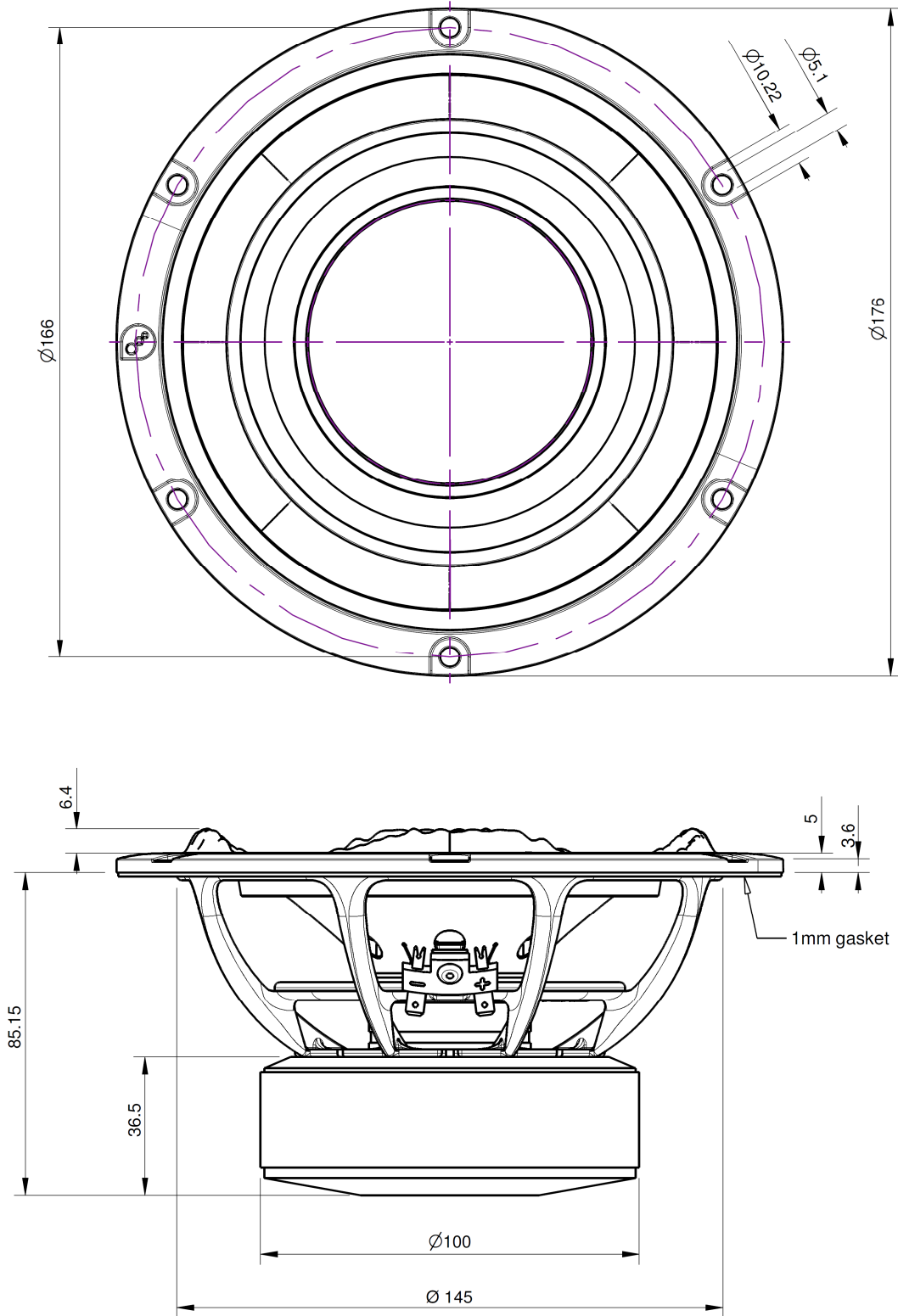

Figure 10 Intermodulation Distortion @ 50Hz 80dB, 425Hz 80dB

## 2 Drawings



Accuracy of Information: To the extent PURIFI ApS provides information on function and specifications, PURIFI ApS attempts to be as accurate as possible. However, PURIFI ApS does not warrant the accuracy of information on its website and other documents as accurate, complete, reliable, current, or error-free. All data and information in the Data Sheet are subject to change.