

# UMIK-X

## DISTRIBUTED MICROPHONE ARRAY

### User Manual

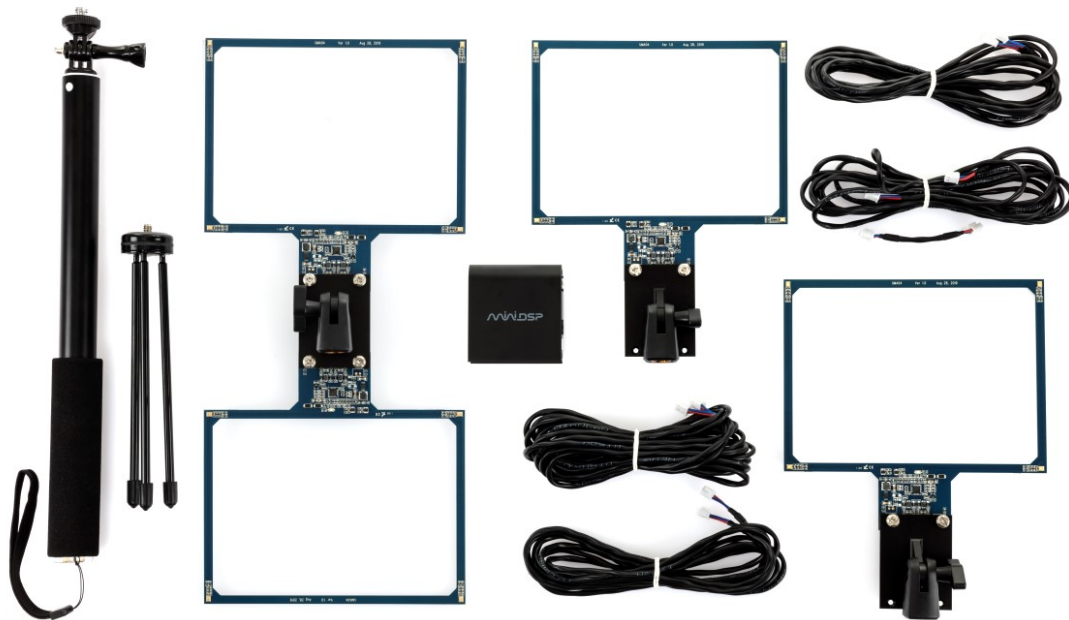



## Revision history

Revision	Description	Date
0.2	Preliminary	15 March 2020
0.3	Second Preliminary	1 June 2020
0.4	Added screenshots for Mac	8 June 2020
0.5	Updated support links	6 July 2020
0.6	Added 4-channel firmware	21 August 2020
0.7	Diagram for 4-channel firmware	17 October 2020

## TABLE OF CONTENTS

---

<b>Important Information</b> .....	<b>4</b>
<b>1 Product Overview</b> .....	<b>6</b>
<b>2 Hardware Connectivity</b> .....	<b>7</b>
<b>3 Installation and Configuration – Windows</b> .....	<b>13</b>
3.1 Download .....	13
3.2 USB driver installation .....	13
3.3 4-channel firmware .....	14
3.4 UAC2 Control Panel .....	15
<b>4 Installation and Configuration – Mac OS X</b> .....	<b>17</b>
4.1 Download .....	17
4.2 4-channel firmware .....	17
4.3 Configuration in Audio MIDI Setup .....	18
<b>5 Room EQ Wizard Multichannel Measurement</b> .....	<b>19</b>
5.1 Enabling the license .....	19
5.2 Configuring REW Preferences – Windows.....	20
5.2.1 miniDSP ASIO driver .....	20
5.2.2 ASIO4ALL.....	21
5.2.3 Selecting the calibration file .....	21
5.3 Configuring REW Preferences – macOS/OS X .....	22
5.3.1 Select input and output.....	22
5.4 Running a multichannel measurement .....	24
<b>6 Additional Information</b> .....	<b>26</b>
6.1 Specifications.....	26
6.1.1 USB-A2B interface .....	26
6.1.2 UMA-4 Module .....	26
6.2 Firmware upgrade .....	27
6.2.1 Windows.....	27
6.2.2 macOS.....	29
6.3 Obtaining support.....	31



## IMPORTANT INFORMATION

---

Please read the following information before use. In case of any questions, please contact miniDSP via the support portal at [support.minidsp.com](http://support.minidsp.com).

### Disclaimer/Warning

miniDSP cannot be held responsible for any damage that may result from the improper use or incorrect configuration of this product. Please read this manual carefully to ensure that you fully understand how to operate and use this product, as incorrect use or use beyond the parameters and ways recommended in this manual have the potential to cause damage to your audio system.

Please also note that many of the questions we receive at the technical support department are already answered in this User Manual and in the online [application notes](#) on the miniDSP.com website. So please take the time to carefully read this user manual and the online technical documentation. Thank you for your understanding!

### Warranty Terms

miniDSP Ltd warrants this product to be free from defects in materials and workmanship for a period of one year from the invoice date. Our warranty does not cover failure of the product due to incorrect connection or installation, improper or undocumented use, unauthorized servicing, modification or alteration of the unit in any way, or any usage outside of that recommended in this manual. If in doubt, contact miniDSP prior to use.

### FCC Class B Statement

This device complies with Part 15 of the FCC Rules. Operation is subject to the following two conditions:

- This device may not cause harmful interference.
- This device must accept any interference received, including interference that may cause undesired operation.

**Warning:** This equipment has been tested and found to comply with the limits for a Class B digital device, pursuant to Part 15 of the FCC Rules. These limits are designed to provide reasonable protection. This equipment generates, uses and can radiate radio frequency energy and, if not installed and used in accordance with the instructions, may cause interference to radio communications. However, there is no guarantee that interference will not occur in a particular installation. If this equipment does cause harmful interference to radio or television reception, which can be determined by turning the equipment off and on, the user is encouraged to try to correct the interference by one or more of the following measures:

- Reorient or relocate the receiving antenna.
- Increase the separation between the equipment and receiver.
- Connect the equipment into an outlet on a circuit different from that to which the receiver is connected.
- Consult the dealer or an experienced radio/TV technician for help.

**Notice:** Shielded interface cable must be used in order to comply with emission limits.

**Notice:** Changes or modification not expressly approved by the party responsible for compliance could void the user's authority to operate the equipment.

## CE Mark Statement

The UMIK-X has passed the test performed according to European Standard EN 55022 Class B.

## A Note on this Manual

This User Manual is designed for reading in both print and on the computer. If printing the manual, please print double-sided. The embedded page size is 8 ½” x 11”. Printing on A4 paper will result in a slightly reduced size.

For reading on the computer, we have included hyperlinked cross-references throughout the manual. In addition, a table of contents is embedded in the PDF file. Displaying this table of contents will make navigation much easier:

- In Adobe Reader on Windows, click on the “bookmarks” icon at the left. The table of contents will appear on the left and can be unfolded at each level by clicking on the “+” icons.
- In Preview on the Mac, click on the **View** menu and select **Table of Contents**. The table of contents will appear on the left and can be unfolded at each level by clicking on the triangle icons.

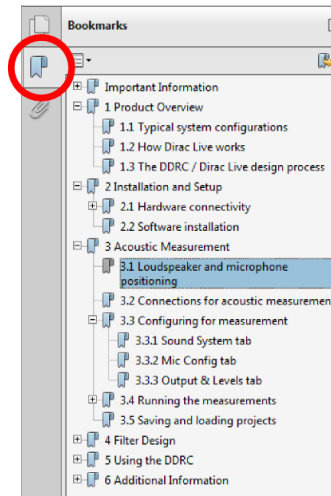

Adobe Reader on Windows

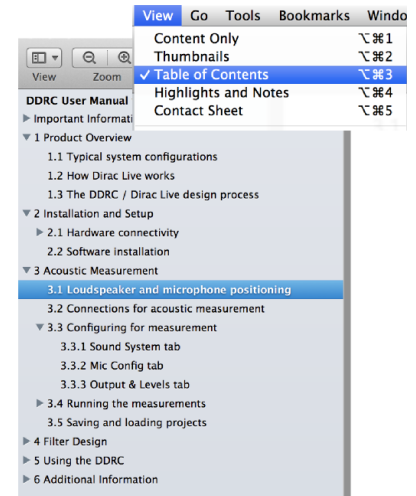

Preview on Mac

## 1 PRODUCT OVERVIEW

---

Thank you for purchasing a miniDSP UMIK-X distributed microphone array. The UMIK-X consists of one to four UMA-4 microphone modules and a USB-A2B interface to interface the modules to the computer. Between four and 16 microphones can therefore be connected. UMA-4 modules are daisy-chained to each other using a single twisted-pair cable carrying the A2B protocol at 44.1 or 48 kHz.

Applications include environmental monitoring and distributed soundfield measurement. The distributed omnidirectional microphones in the array allow quick measurement and analysis in applications such as room and hall equalization and distributed subwoofer tuning.

The USB-A2B interface includes a stereo optical output to simplify generation of test audio signals.

The UMIK-X is compatible with the multi-channel measurement capability of Room EQ Wizard. A license for the multi-channel upgrade is included with your purchase of the UMIK-X.



Each UMA-4 microphone module is a bare circuit board with no environmental protection. It is intended for prototyping and indoor use. Outdoor use is not recommended, as exposure to moisture and dust may damage the modules.

## 2 HARDWARE CONNECTIVITY

Figure 1 shows the physical structure of the UMA-4 microphone module. Four MEMS microphones are positioned in a rectangle at approximately 170 mm x 125 mm centers. Two lugs with screw threads are used for mounting to a microphone stand adapter (supplied). Channel numbering within each module is as shown. Headers for the two A2B ports A are located as shown. (A third header above one of the threaded lugs is not intended for end-user access.)

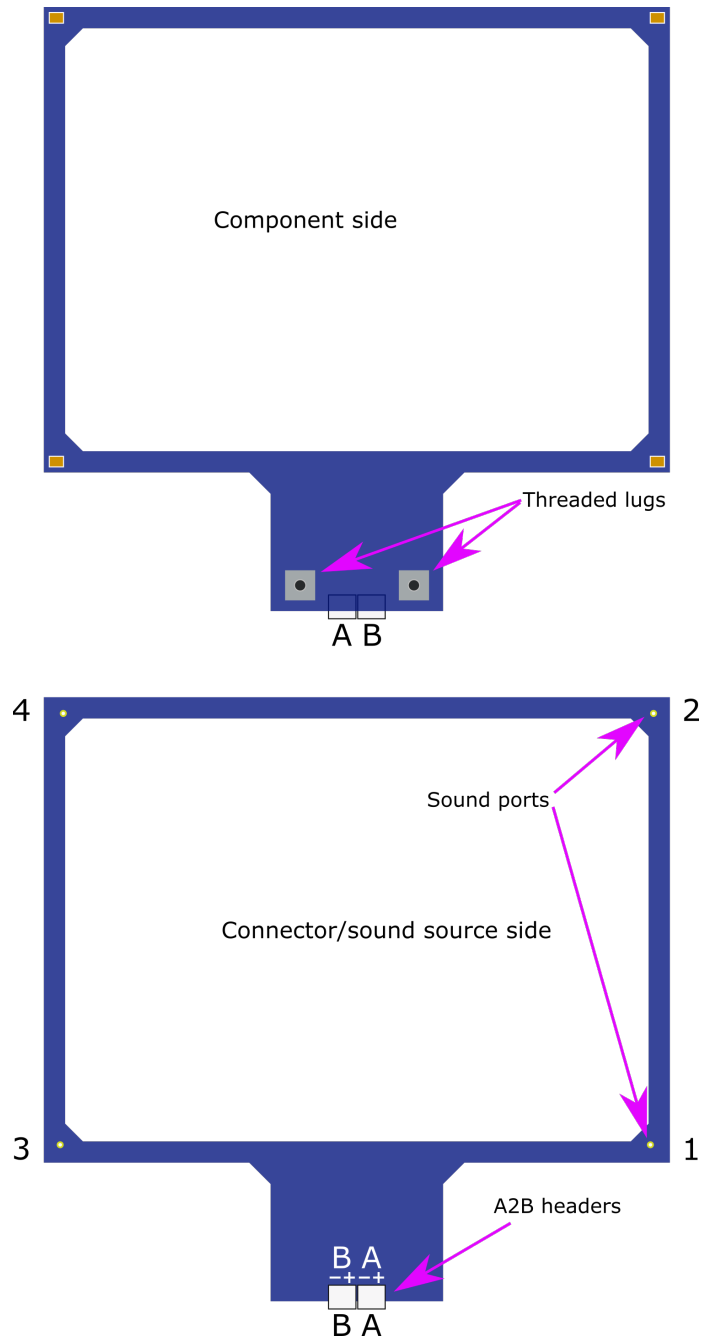
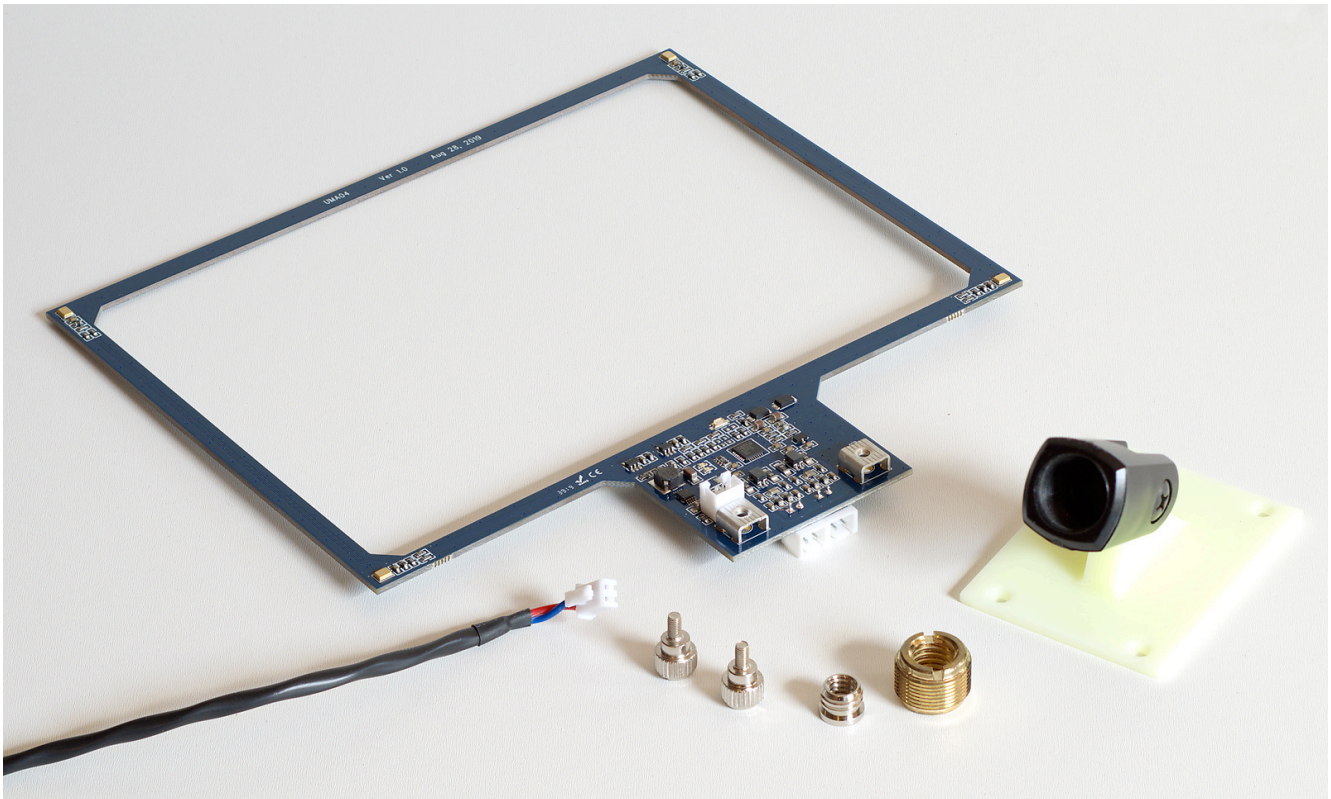

Figure 1. UMIK-X physical structure

Figure 2 shows a UMA-4 module with the various parts provided:

- The UMA-4 module itself.
- A twisted-pair cable for connecting modules and the USB-A2B interface.
- Two thumb screws to fasten the UMA-4 to the stand adapter.
- Two thread adapters: ¼" to 3/8" and 3/8" to ½". These enable the UMA-4 to be mounted to a wide variety of camera and microphone stands.
- The stand adapter. One or two UMA-4 modules can be mounted to the adapter.



*Figure 2. UMA-4 microphone module and provided parts*



Figure 3 illustrates a single UMA-4 module mounted to the stand adapter, which is in turn mounted onto a microphone stand. When using a single module, the twisted pair cable to the USB-A2B interface plugs into the “A” jack as shown.

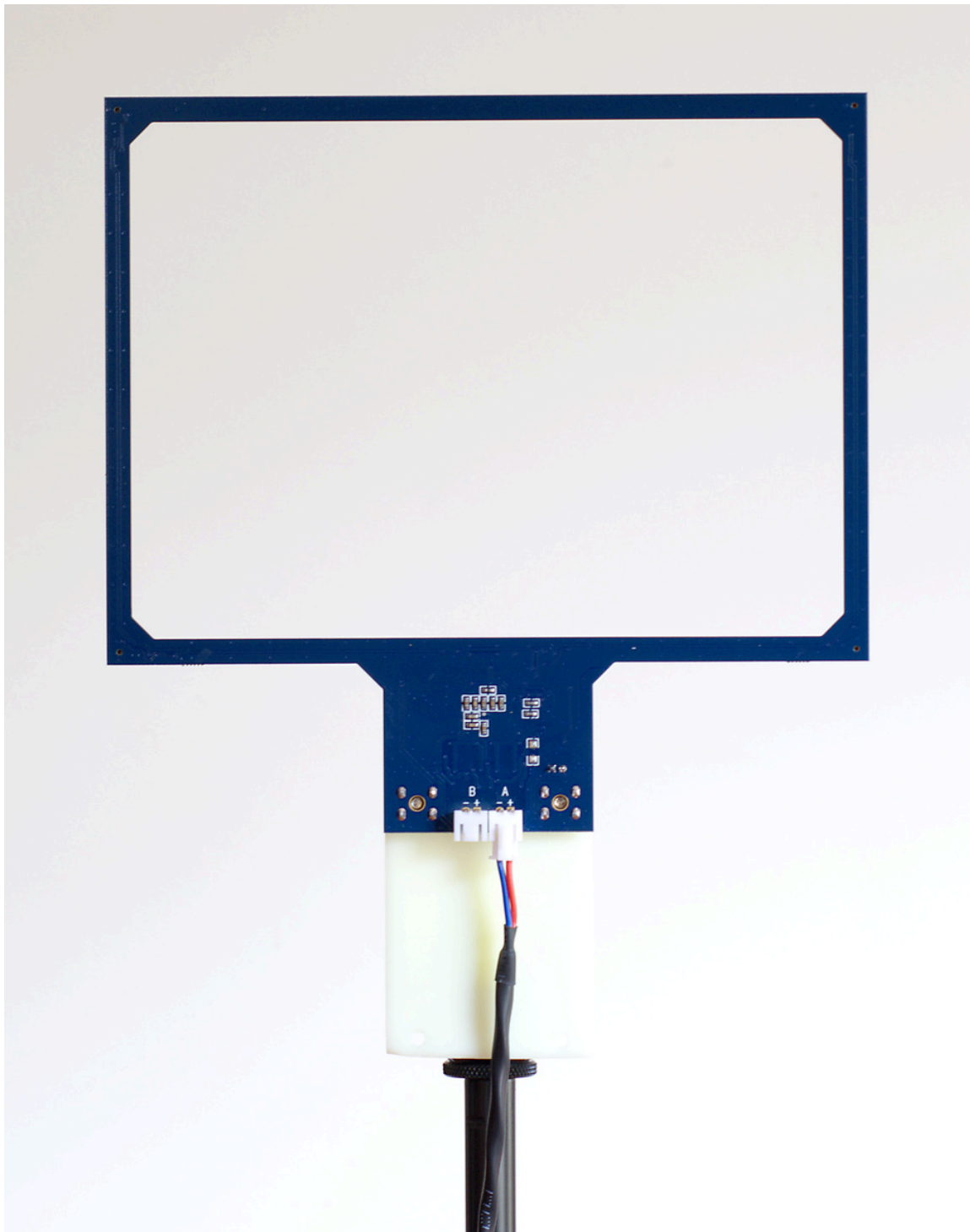

*Figure 3. Single UMA-4 module on microphone stand (connector/sound source side)*

Each pair of UMA-4 modules is provided with a short 8 cm twisted-pair cable. This is used when mounting two modules onto a single stand, as shown in Figure 4.

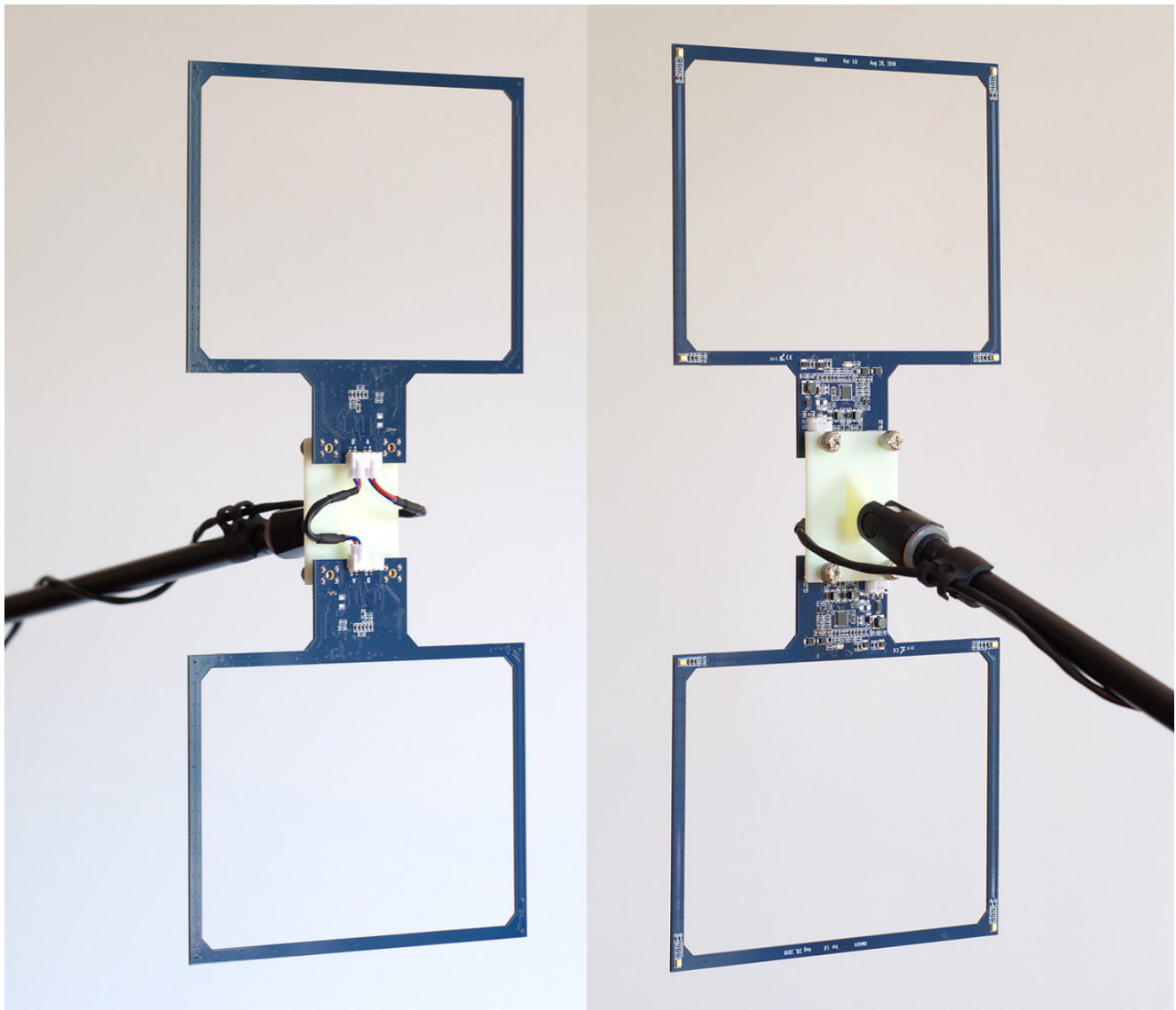

Figure 4. Dual UMA-4 modules mounted on a single stand with boom arm

Figure 5 shows the panel connections for the USB-A2B interface. The **Optical IN** is not active. **Optical OUT** is typically used to output test signals. The USB-A2B interface is powered by an external 5V supply through a micro-USB Type B connector. A 5V 2A USB power supply for this purpose is included with the USB-A2B.

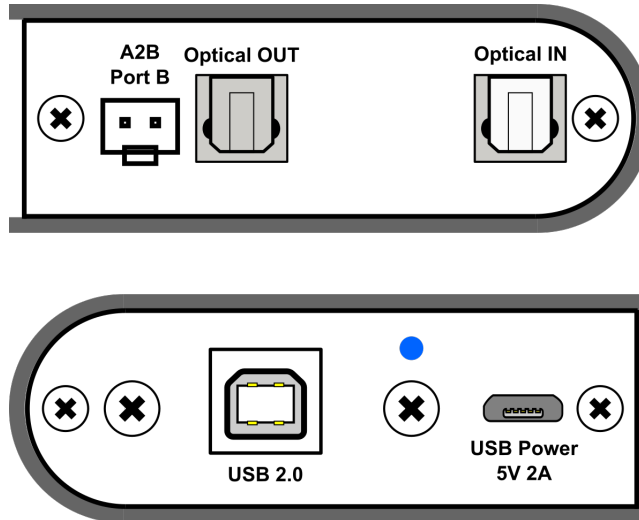

Figure 5. USB-A2B interface

Figure 6 illustrates how the UMIK-X is connected. Note that the power supply is equipped with a USA-style pair of power pins that fold out from the body. Adapters for UK, EU and AU power are included and can be fitted to the supply by folding down the pins and sliding the adapter into the slot until it locks.

Here is a standard procedure for getting connected:

1. Connect a free USB (2.0 compatible) port on your computer to the Type B port on the USB-A2B.
2. Connect the “B” A2B port on the USB-A2B to the “A” port on the first UMA-4 module.
3. Connect the “B” port of the first UMA-4 module to the “A” port on the second module (if present).
4. Repeat for the third and fourth modules (if present).
5. Plug in the provided 5V 2A USB power supply to mains power. Connect the USB port on the power supply to the micro USB power port on the interface.



All microphone modules must be connected before applying power to the USB-A2B interface, otherwise the modules will not be recognized.



The power supply must supply adequate power to the modules. We recommend using the provided power supply (5V 2A) or equivalent, and not using e.g. a computer USB port to supply power.

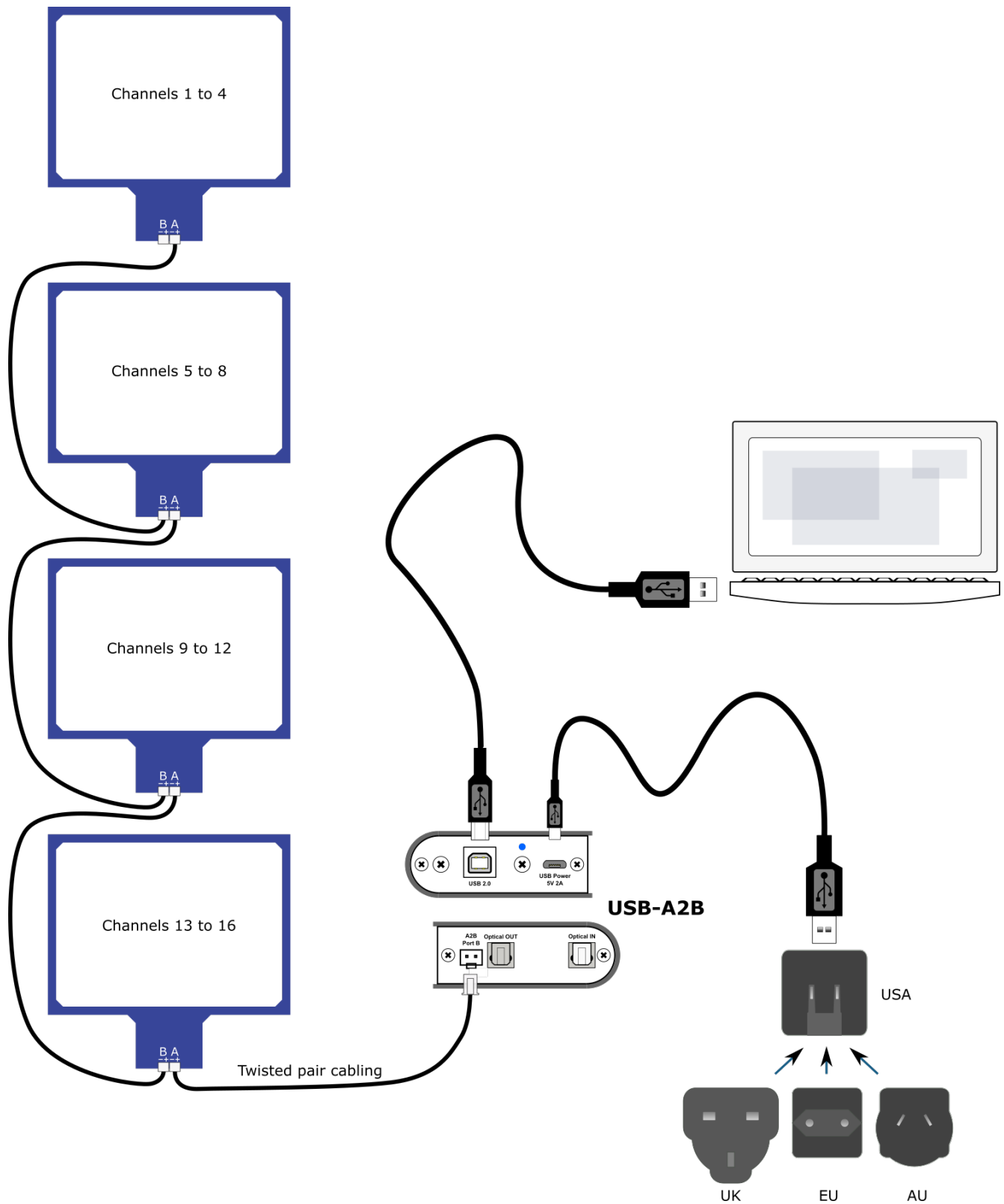

Figure 6. UMIK-X connections

## 3 INSTALLATION AND CONFIGURATION – WINDOWS

---

For use with Windows, the miniDSP driver must be installed. You will also need to download the software package if there is a firmware upgrade.

### 3.1 DOWNLOAD

If you purchased your product directly from miniDSP, your software will be available from the [User Downloads](#) section of the miniDSP website when your order ships. You will need to be logged into the website with the account you created when purchasing to access the download.

If you purchased your product from a miniDSP dealer, you will receive a coupon together with the product. Redeem this coupon and select the Plugin Group “UMIK-X” at the link below:

- <https://www.minidsp.com/support/redeem-coupon>

The User Downloads link is visible from the dropdown menu at the top right of the website page:

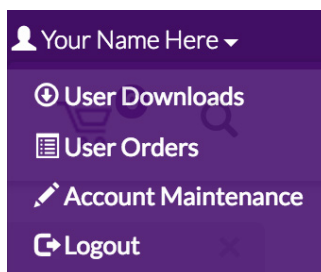

Navigate to the **USB Audio Drivers** section and download the zip file under the heading **UMIK-X**. Unzip the downloaded file by right-clicking on it and selecting “Extract All...”.

### 3.2 USB DRIVER INSTALLATION

The USB driver enables Windows to stream audio to the UMIK-X. In addition, it installs a control panel to help manage the UMIK-X.

To install the driver, go to the **WinDrivers** folder of the installation download and double-click on the installer:

- **miniDSP\_UAC2\_v4.67.0\_2019-08-15\_setup.exe**

(The version number embedded in the filename may be different.)

We recommend accepting the default installation location. Once the driver installation completes, click the **Finish** button.

### 3.3 4-CHANNEL FIRMWARE

By default, all channels of each UMA-4 modules are provided to the computer over USB, for a total of up to 16 channels. In some applications, it is desired to produce only a single channel from each UMA-4, for a total of up to 4 channels.

To install this version of the firmware, follow the procedure starting on page 27. Choose the firmware file **UMIK-X-4CH\_v1.2.bin** to load into the UMA-4. (The version number “v1.2” may be different.)

All other procedures to use the UMIK-X in this manual are the same, except that (if you have four UMA-4 modules) REW or other measurement software will see only four channels from the UMIK-X. The active capsule in 4-channel mode is capsule 2 (Figure 7).

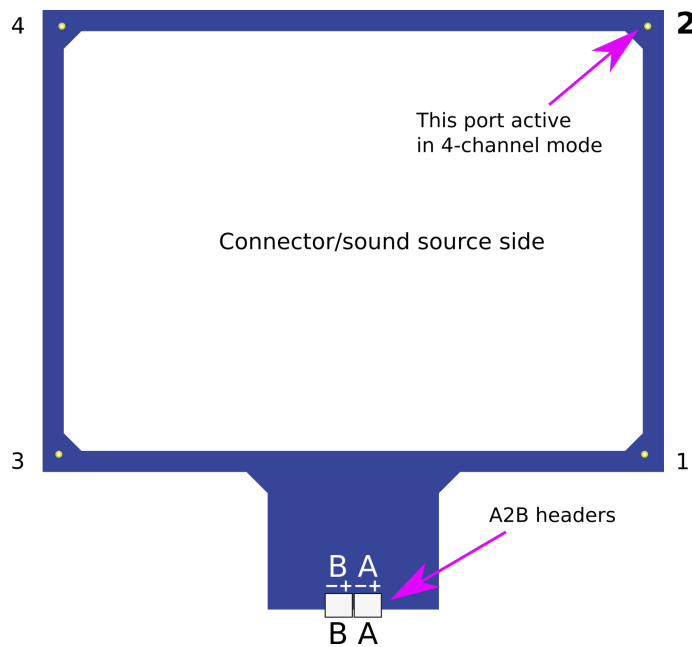

Figure 7. Active capsule in 4-channel mode

### 3.4 UAC2 CONTROL PANEL

To configure the UMIK-X, open the **miniDSP UAC2 Control Panel** (from Start Menu -> miniDSP Ltd). It has several tabs.

#### Status

This tab shows the current sample rate of the UMIK-X. This setting cannot be changed in the Control panel, but simply reflects the current sample rate of the UMIK-X.

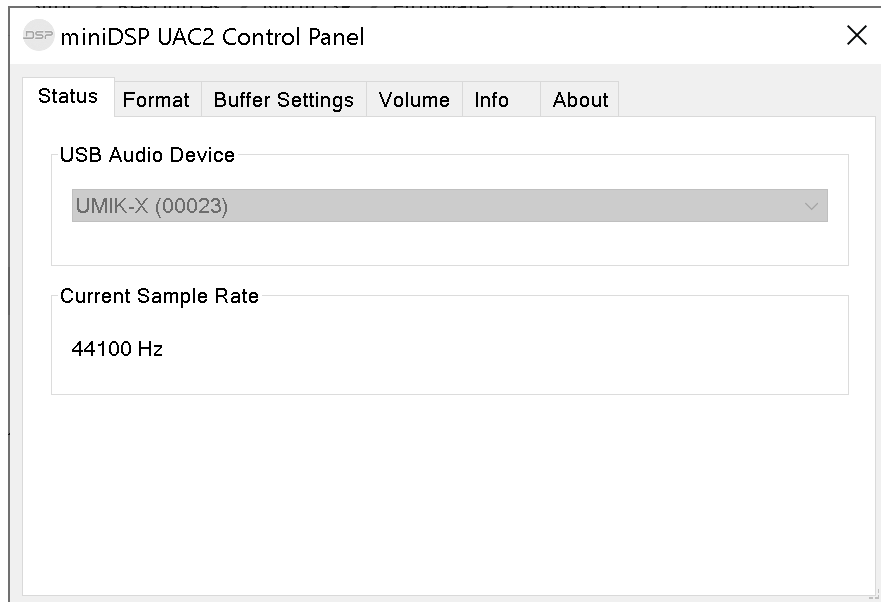

#### Format

This tab shows the input and output channel word lengths:

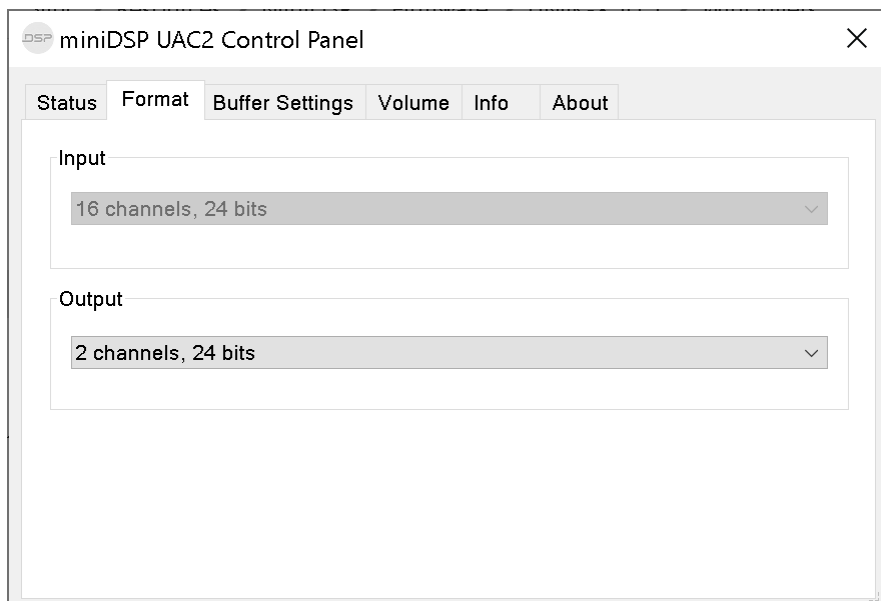

## Info

This pane shows information about the UMIK-X.

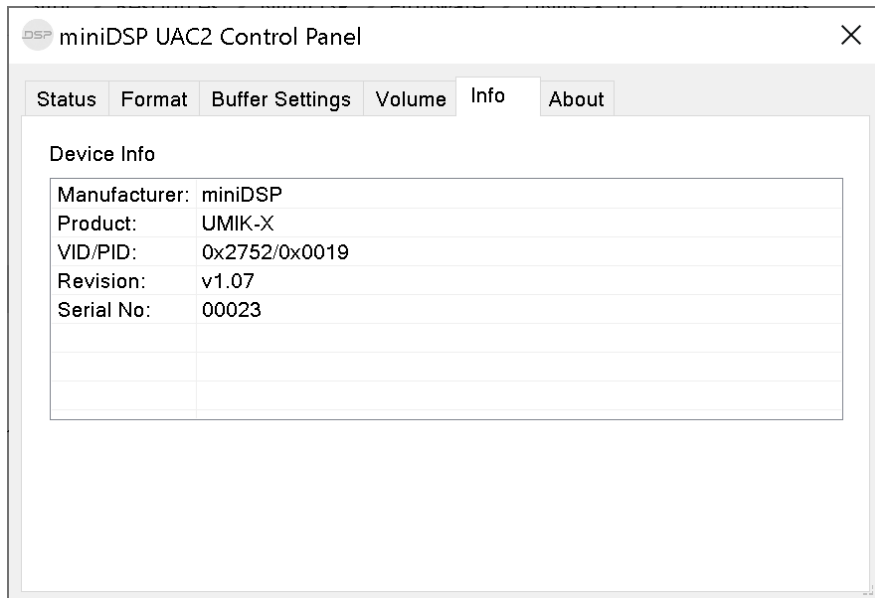

## About

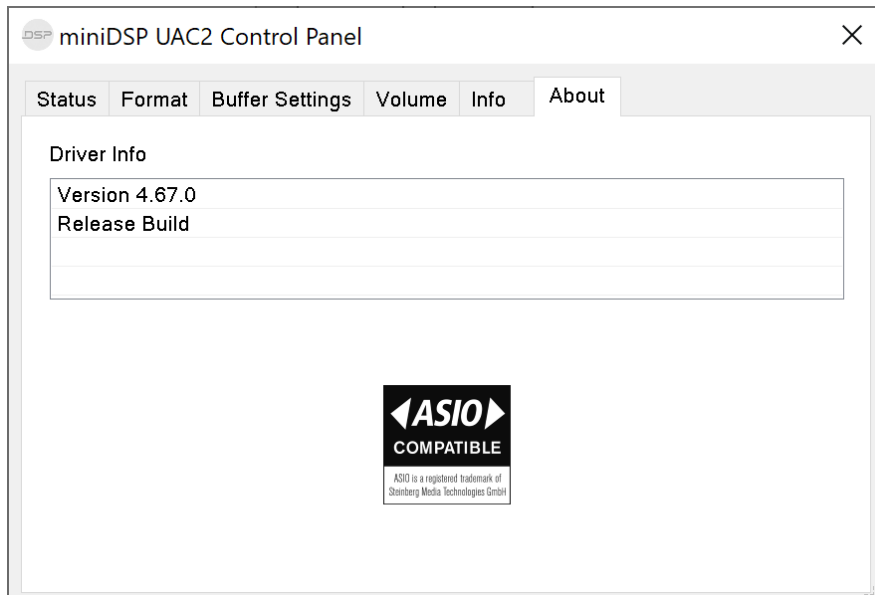



## 4 INSTALLATION AND CONFIGURATION – MAC OS X

---

Mac OS X / macOS has native support for USB Audio class 2.0 devices, so no driver installation is required. You may need to download the software package to update firmware.

### 4.1 DOWNLOAD

If you purchased your product directly from miniDSP, your software will be available from the [User Downloads](#) section of the miniDSP website when your order ships. You will need to be logged into the website with the account you created when purchasing to access the download.

If you purchased your product from a miniDSP dealer, you will receive a coupon together with the product. Redeem this coupon and select the Plugin Group “UMIK-X” at the link below:

- <https://www.minidsp.com/support/redeem-coupon>

The User Downloads link is visible from the dropdown menu at the top right of the website page:

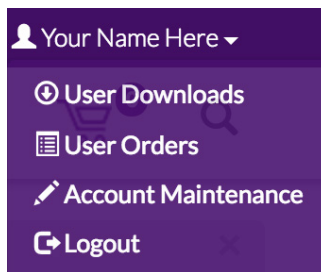

Navigate to the **USB Audio Drivers** section and download the zip file under the heading **UMIK-X**. Unzip the downloaded file by double-clicking on it.

### 4.2 4-CHANNEL FIRMWARE

By default, all channels of each UMA-4 modules are provided to the computer over USB, for a total of up to 16 channels. In some applications, it is desired to produce only a single channel from each UMA-4 for a total of up to 4 channels.

To install this version of the firmware, follow the procedure starting on page 29. Choose the firmware file **UMIK-X-4CH\_v1.2.bin** to load into the UMA-4. (The version number “v1.2” may be different.)

All other procedures to use the UMIK-X in this manual are the same, except that (if you have four UMA-4 modules) REW or other measurement software will see only four channels from the UMIK-X.

### 4.3 CONFIGURATION IN AUDIO MIDI SETUP

Open the program **Audio MIDI Setup** (in **Applications->Utilities**). Click on the device UMIK-X that appears in the list on the left. This will display the input and output channels. The **Format** drop-down menu will show the supported sample rates. For the input channels:

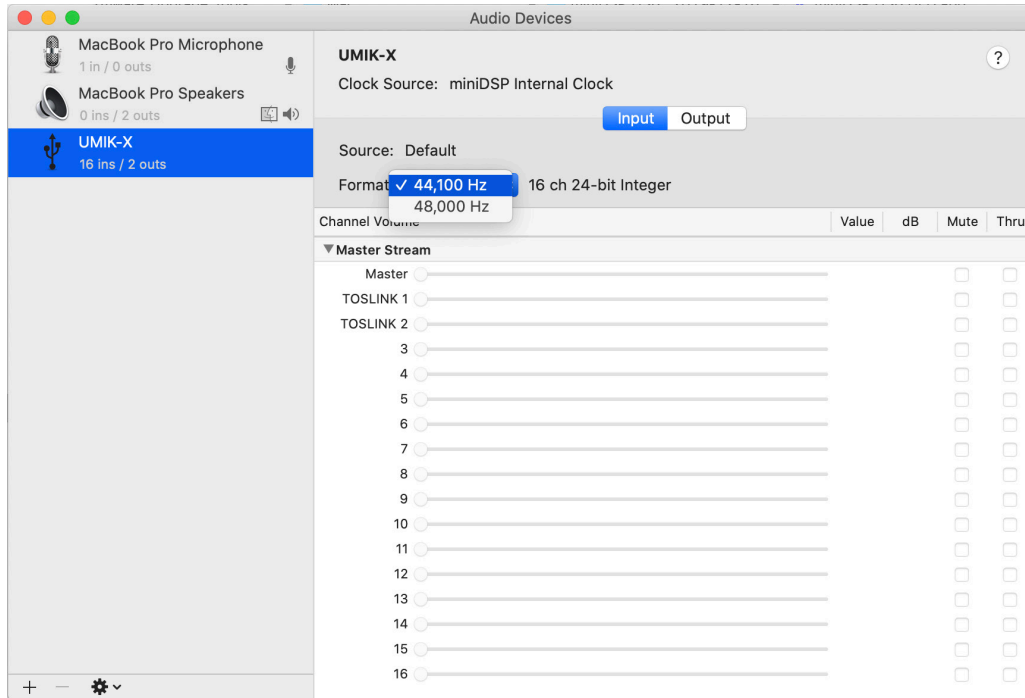

For the output channels:

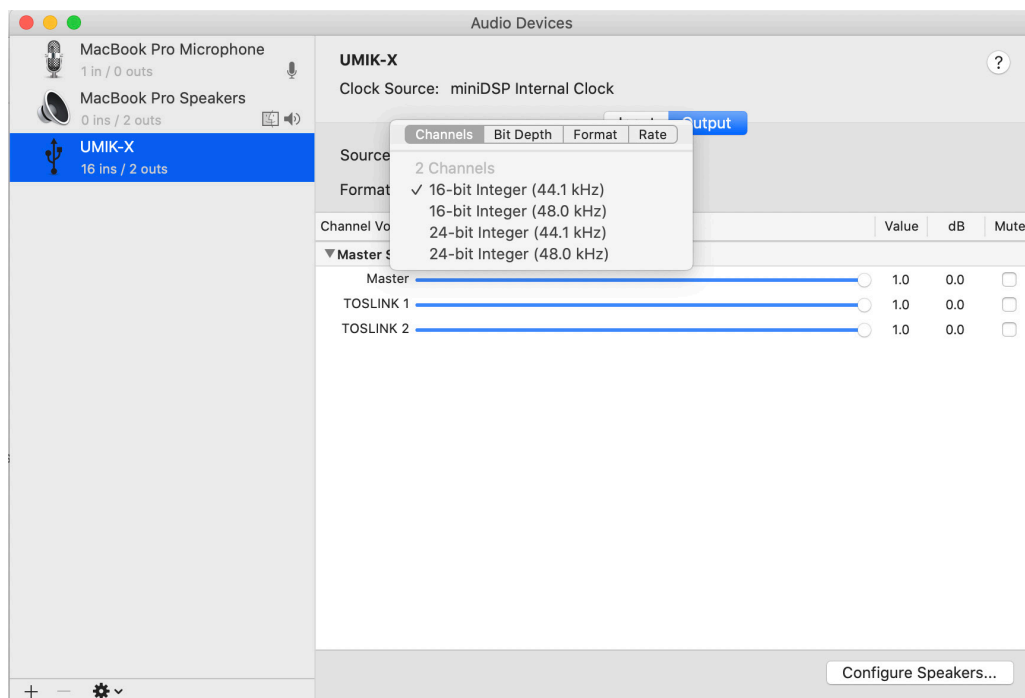

## 5 ROOM EQ WIZARD MULTICHANNEL MEASUREMENT

---

The UMIK-X is provided with a license for the multichannel measurement feature of Room EQ Wizard (REW).

### 5.1 ENABLING THE LICENSE

To enable your license, drop down the Upgrades menu and select Multichannel measurement. Paste in your license code.

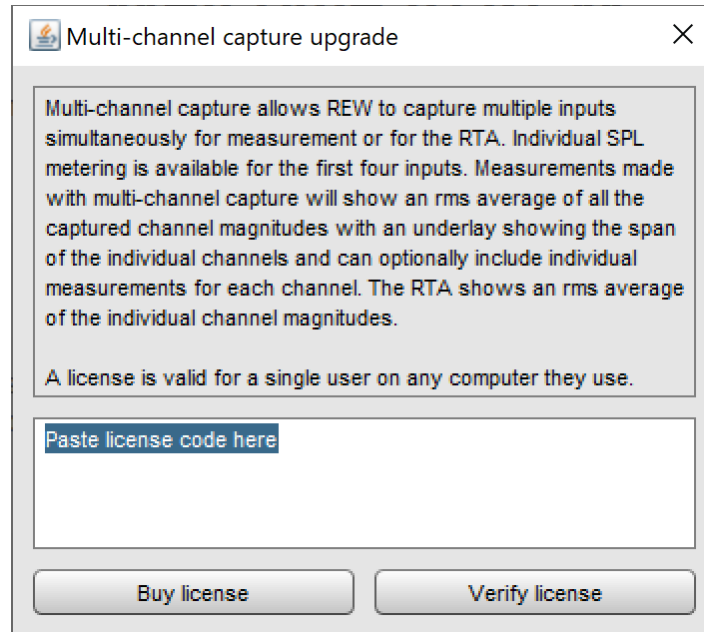

You will need to quit REW and start it again for the license to take effect:

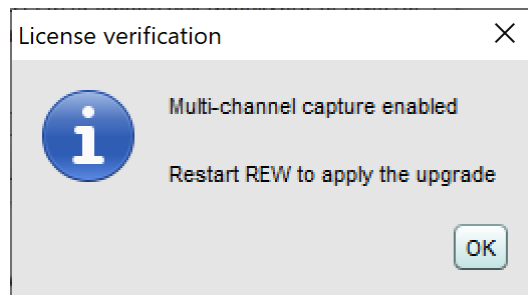

## 5.2 CONFIGURING REW PREFERENCES – WINDOWS

To use the UMIK-X, open the Preferences window (the wrench/spanner icon at top right). You will need to decide on how to allow REW to output test signals as well as to select the UMIK-X for audio input.

### 5.2.1 miniDSP ASIO driver

The A2B interface has a standard optical stereo output (TOSLINK). The simplest method of sending test audio from REW is to connect this optical output to a device that has an optical input. For example:

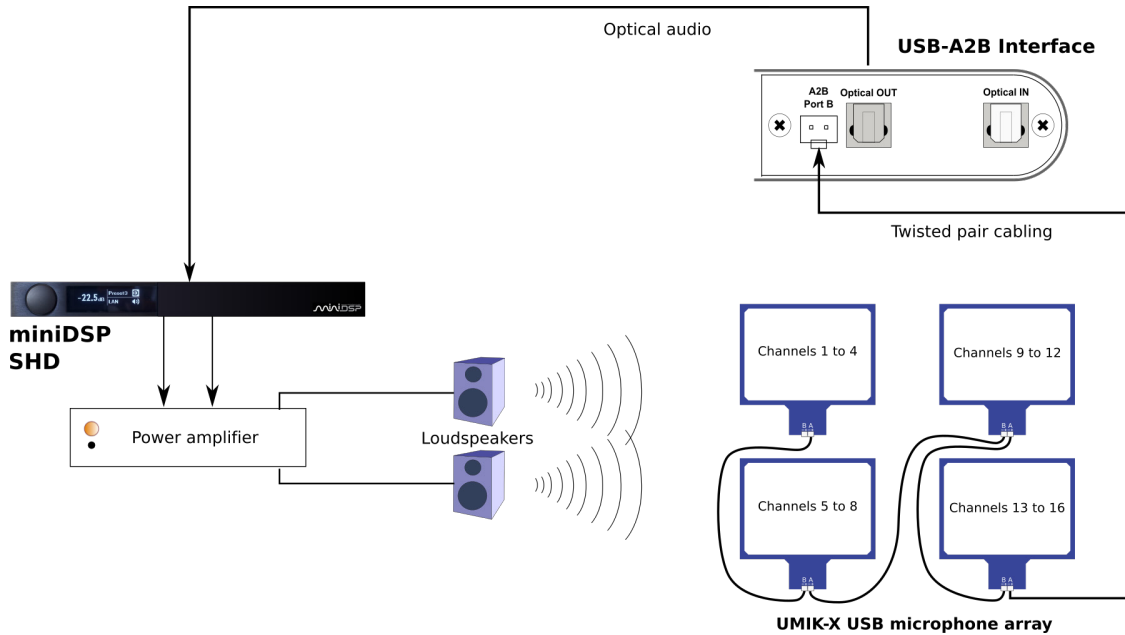

In this case, you can use the miniDSP ASIO driver directly. In the REW Preferences window, first select ASIO under **Drivers** (top left of Preferences screen). Then select the miniDSP ASIO Driver under **ASIO Device**. Select the input and output channels as shown:

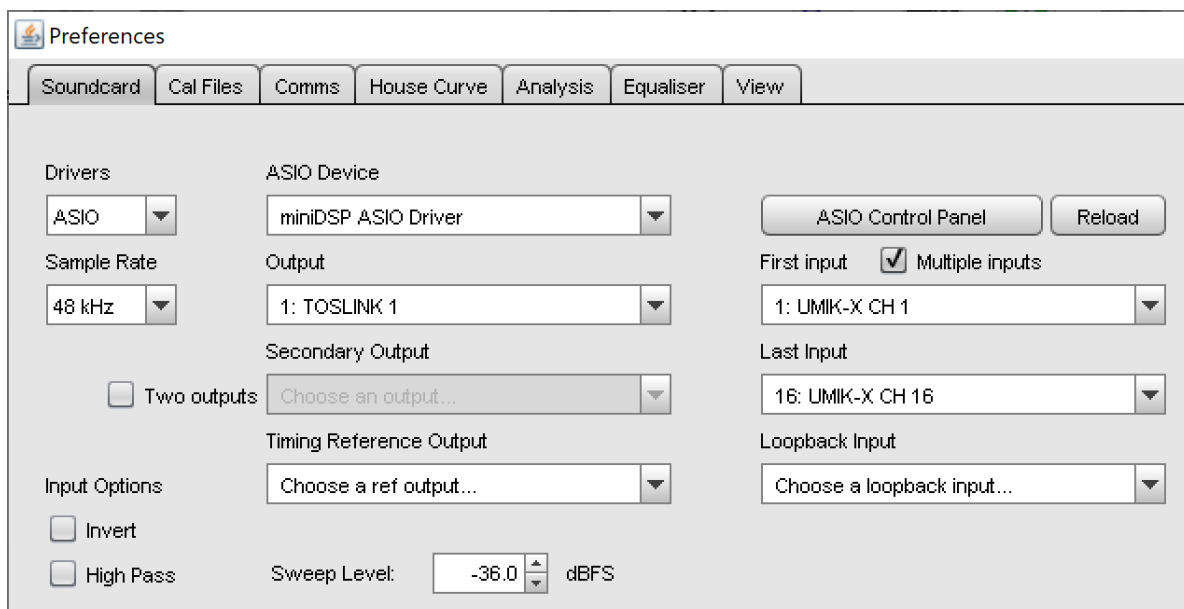

### 5.2.2 ASIO4ALL

If you need to output audio via some other audio interface on your PC, you will need to use ASIO4ALL. First download it from <http://www.asio4all.org> and install it.

In the REW Preferences window, select ASIO as the “Drivers” option, then ASIO4ALL as the ASIO Device.

Click on the ASIO Control Panel button. Click on the wrench/spanner icon at the lower right to enable advanced mode. Then select the desired input and output devices from the list on the left. Disable unused devices. In this example, we are using the miniDSP SHD as the output device and the UMIK-X as the input device:

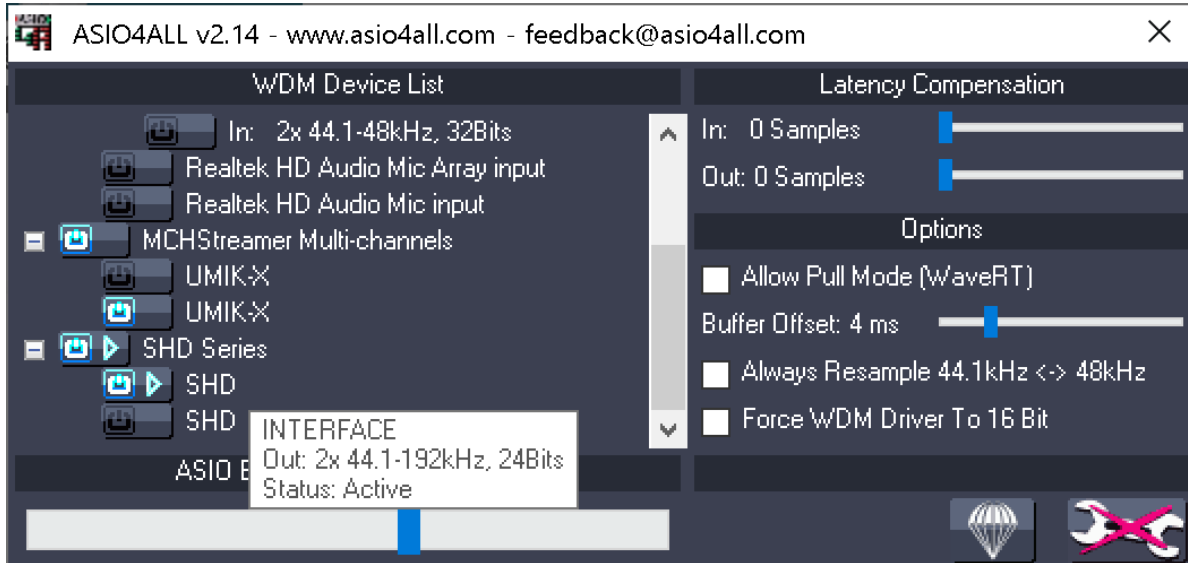

Note that there are two entries for the UMIK-X and the SHD, as both have input and output channels. Hover your mouse over them to see which is which, and enable the input channels of the UMIK-X and the output channels of the SHD (or other output device).

### 5.2.3 Selecting the calibration file

The UMIK-X comes supplied with a generic calibration file. Download it from the UMIK-X page. Use the **Cal File** tab of REW Preferences to select it as the calibration file for the miniDSP ASIO driver or for ASIO4ALL, according to how you have your I/O configured.

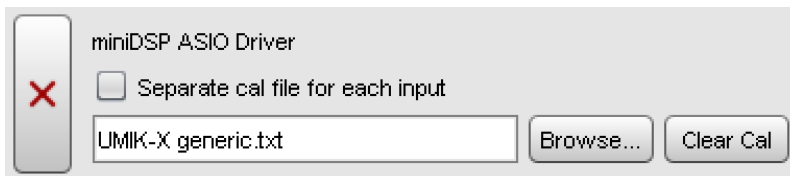

Note that – even with the calibration file – the UMIK-X does not have same level of accuracy as the UMIK-1. The polar response is not symmetrical at high frequencies. The benefit of the UMIK-X is its ability to make multiple measurements at the same time. This can also mean that repeated measurements are more accurate as there is no need to move a single microphone to different locations.

### 5.3 CONFIGURING REW PREFERENCES – MACOS/OS X

Open the Preferences window (the wrench/spanner icon at top right).

#### 5.3.1 Select input and output

The A2B interface has a standard optical stereo output (TOSLINK). The simplest method of sending test audio from REW is to connect this optical output to a device that has an optical input. For example:

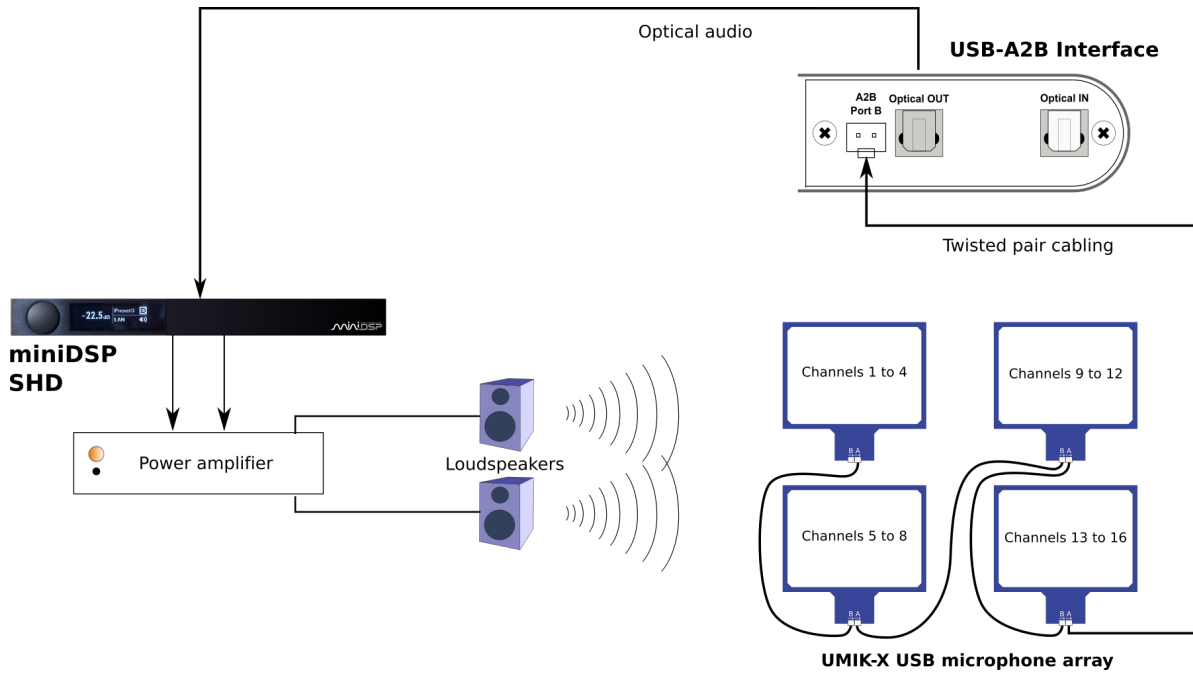

In this case, select the UMIK-X for both input and output:

Sample Rate	Output Device	Buffer	Input Device	Buffer
48 kHz	UMIK-X	32k	UMIK-X	32k
	Output		First input <input checked="" type="checkbox"/> Multiple inputs	
	UMIK-X	L	UMIK-X	1
	Timing Reference Output	L	Last Input	16
			Loopback Input	2

If you want to send audio from your Mac via a different device, select it as the output device. For example, to send audio over USB to a miniDSP SHD processor:

Sample Rate	Output Device	Buffer	Input Device	Buffer
48 kHz	SHD	32k	UMIK-X	32k
	Output		First input <input checked="" type="checkbox"/> Multiple inputs	
	SPEAKER	L	UMIK-X	1
	Timing Reference Output	L	Last Input	16
			Loopback Input	2

### 5.3.1.1 Selecting the calibration file

The UMIK-X comes supplied with a generic calibration file. Download it from the UMIK-X page. Use the **Cal File** tab of REW Preferences to select it:

X

UMIK-X UMIK-X

Separate cal file for each input

UMIK-X generic.txt Browse... Clear Cal

Note that – even with the calibration file – the UMIK-X does not have same level of accuracy as the UMIK-1. The polar response is not symmetrical at high frequencies. The benefit of the UMIK-X is its ability to make multiple measurements at the same time. This can also mean that repeated measurements are more accurate as there is no need to move a single microphone to different locations.

## 5.4 RUNNING A MULTICHANNEL MEASUREMENT

Click on the Measure button. At the lower right of the measurement window, check that “Multiple inputs” is selected and that your desired range of channels is selected.

If “Generate individual measurements” is **not** selected, as shown above, you will get a single measurement that shows the range covered by all the measurements, and the average of all measurements:

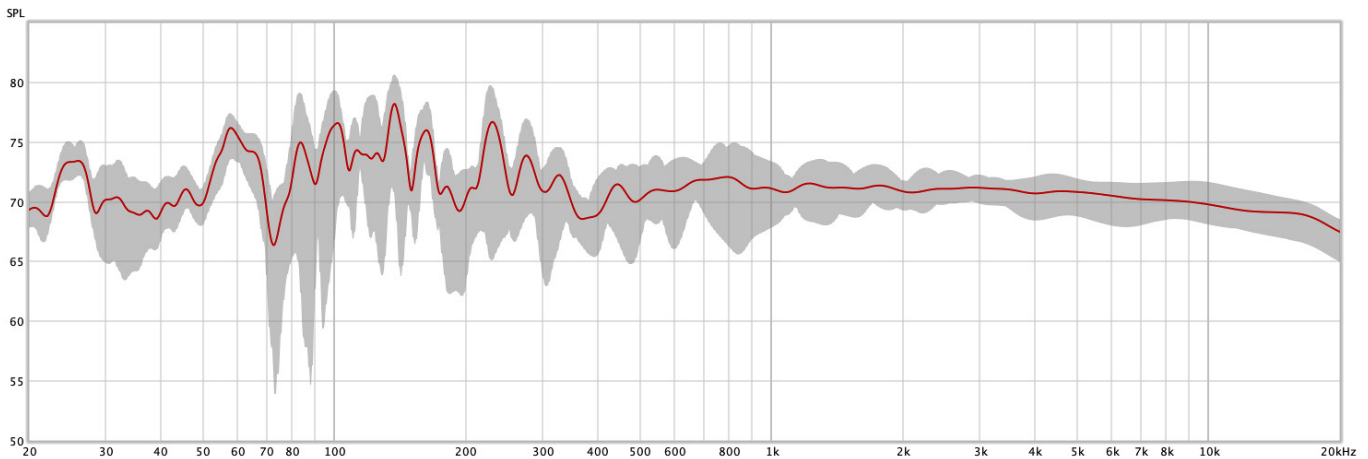

The usual graph display controls work on this graph, such as limits and smoothing. (The example above uses “Var smoothing.”)

If “Generate individual measurements” **is** selected, each microphone will produce a separate measurement. In addition, the same measurement that shows the range covered by all the measurements and their average will be produced. (In other words, up to 17 individual measurement graphs will be produced from one sweep.)



Measurement of all 16 channels may not always be desired, in which case a smaller number of channels can be measured. For example, to measure using the microphones on just one module (channels 9 through 12):

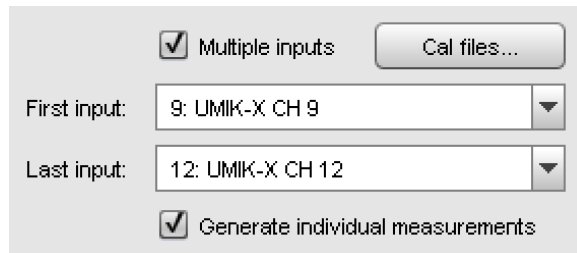

Here is the combined measurement in this case. There is much less variation than the 16-channel example because the microphones on a single module are relatively close together.

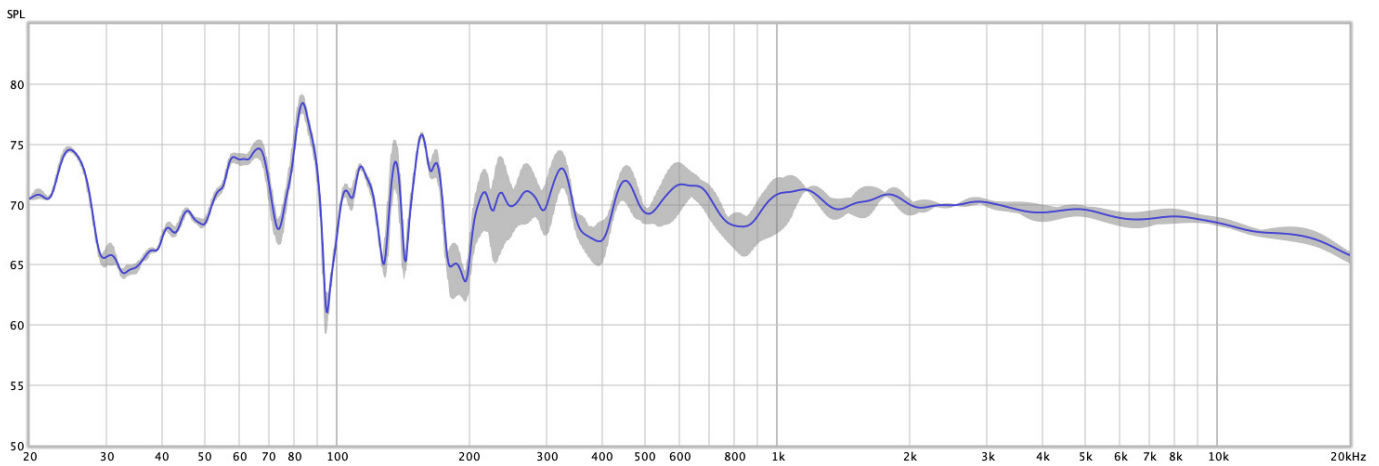

Note: when choosing channels, remember that channel 1 is “furthest” from the computer. See Figure 6.

## 6 ADDITIONAL INFORMATION

---

### 6.1 SPECIFICATIONS

#### 6.1.1 USB-A2B interface

<b>USB streaming engine</b>	XMOS Multicore USB audio processor for UAC2 streaming
<b>USB audio capabilities</b>	USB audio recording for up to 16ch audio channels <ul style="list-style-type: none"> <li>• Driverless under OS X, Linux</li> </ul> Custom ASIO drivers for Win10 platforms
<b>Resolution / Sample rate</b>	24-bit @ 44.1/48 kHz
<b>Analog Devices A2B link</b>	Multichannel audio link via A2B protocol, up to 15m between UMA-4 modules and up to 40m total cable length. (Note: the cables provided in the package are a maximum of 5 meters length.)
<b>Toslink</b>	Toslink Out: Stereo link to Playback system / Toslink In: No enabled
<b>LED</b>	Power/Active link indication
<b>Power supply</b>	External 5V USB power supply
<b>Dimensions / Weight</b>	24x64x67mm / 90g
<b>6.1.2 UMA-4 Module<sup>1</sup></b>	
<b>MEMS microphones</b>	4 x Knowles MEMS with low noise buffer and high-performance modulator: <ul style="list-style-type: none"> <li>• Low distortion: 1% @ 130 dB SPL</li> <li>• Sensitivity: -37dBFS @ 94dB SPL (1kHz)</li> <li>• Acoustic Overload Point (AOP): 132.5dB SPL</li> <li>• High SNR: 66 dBA and flat frequency response</li> <li>• RF shielded against mobile interference</li> <li>• Omnidirectional pick-up pattern</li> </ul> Matched sensitivity for uniform response
<b>Mounting</b>	Plastic clamp for microphone mounting
<b>Dimensions (mm) / Weight</b>	172 x 180mm/ 27g

---

<sup>1</sup> Based on MEMS manufacturer specifications

## 6.2 FIRMWARE UPGRADE

miniDSP may occasionally provide an upgrade to the A2B firmware to enable new features. You can also change between 4-channel and 16-channel mode by uploading the corresponding firmware file.

To upgrade the A2B firmware, first download the latest version of the UMIK-X software package from the **User Downloads** section of the miniDSP website, then extract it on your computer (on Windows, right-click and select “Extract All...”; on Mac, double-click).



DO NOT DISCONNECT THE USB CABLE OR POWER FROM THE A2B INTERFACE WHILE FIRMWARE UPGRADE IS IN PROGRESS. DOING SO MAY “BRICK” YOUR INTERFACE.

### 6.2.1 Windows

1. Connect the A2B interface to your computer via USB (if not already connected) and power it on.
2. Navigate to the **XMOS\_Firmware\Firmware\_Upgrade\_Tools\Windows\miniDSPUAC2Dfu** folder of the software download.
3. Double-click on **miniDSPUAC2Dfu.exe** to run it. The application will start:

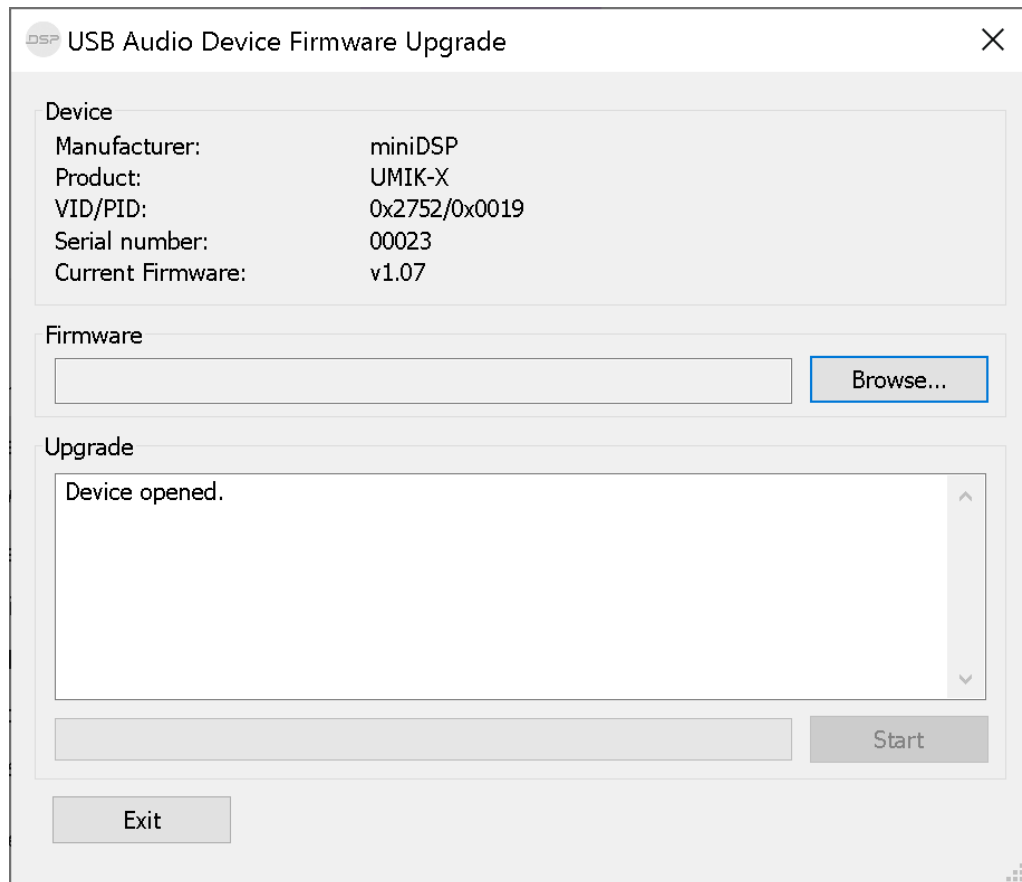

- Click on the **Browse** button and select the firmware file from the **XMOS\_Firmware** folder of the software download. It will have a name like **UMIK-X\_v1.2.bin** for 16-channel mode or **UMIK-X-4CH\_v1.2.bin** for 4-channel mode. (The version number “v1.2” may change.)
- Click on the **Start** button.
- You will get a progress bar as the upgrade proceeds:

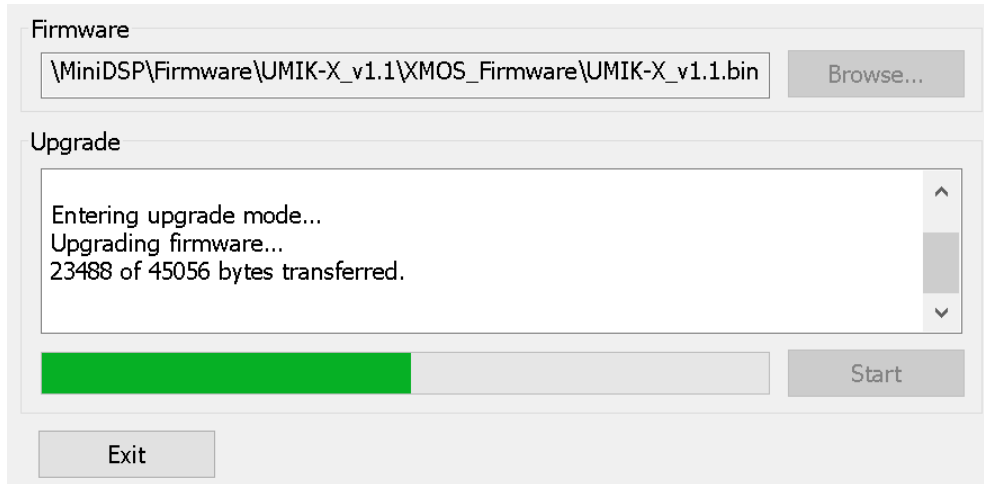

- Once the firmware upgrade completes, you will see a message that the upgrade completed successfully:

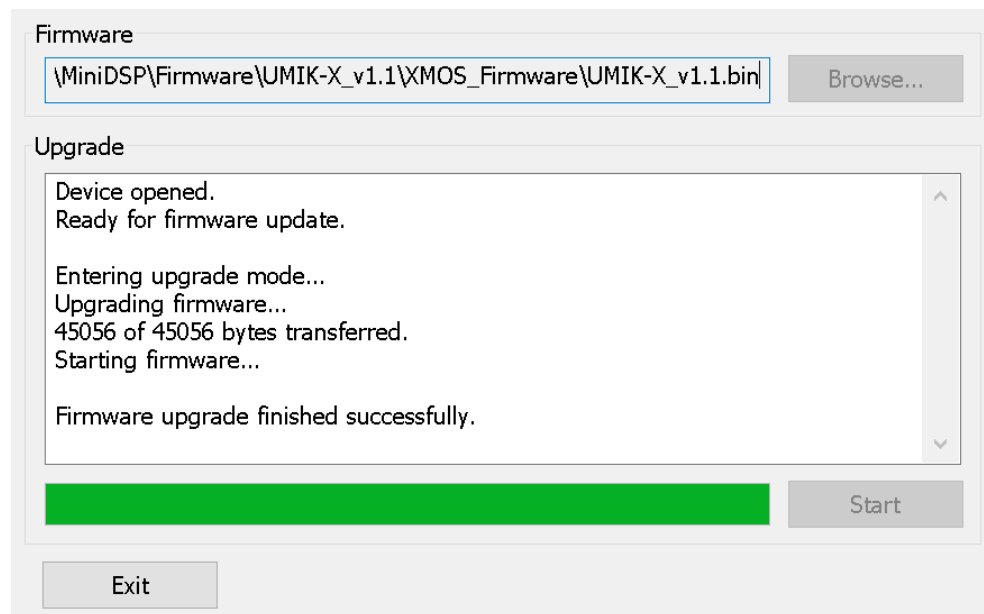

- Click on **Exit**.
- That's it! You're done. You can now use your UMIK-X again.

### 6.2.2 macOS

1. Connect the A2B interface to your computer via USB (if not already connected) and power it on.
2. Navigate to the **XMOS\_Firmware/Firmware\_Upgrade\_Tools/Mac** folder of the software download.
3. Double-click on the .zip file to extract the firmware update software, then double-click on **miniDSP USB DFU.app** to run it. The app will start:

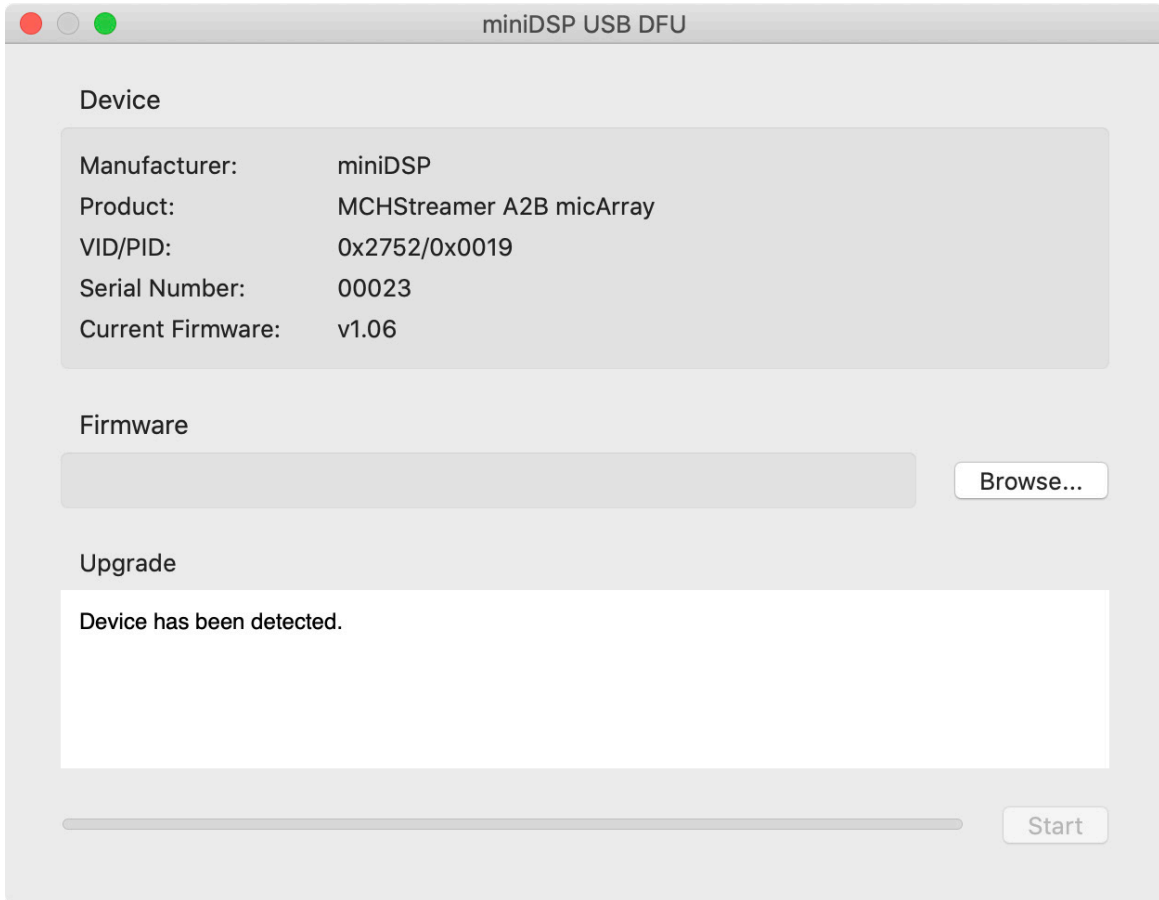

- Click on the **Browse** button and select the firmware file from the **XMOS\_Firmware** folder of the software download. It will have a name like **UMIK-X\_v1.2.bin** for 16-channel mode or **UMIK-X-4CH\_v1.2.bin** for 4-channel mode. (The version number “v1.2” may change.)
- Click on the **Start** button.
- You will get a progress bar as the upgrade proceeds:

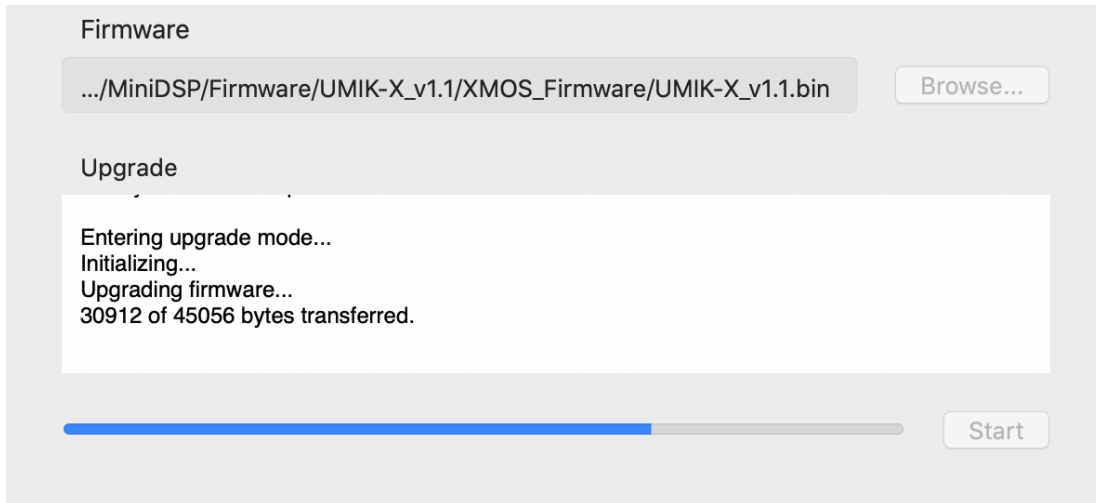

- Once the firmware upgrade completes, you will see a message that the upgrade completed successfully:

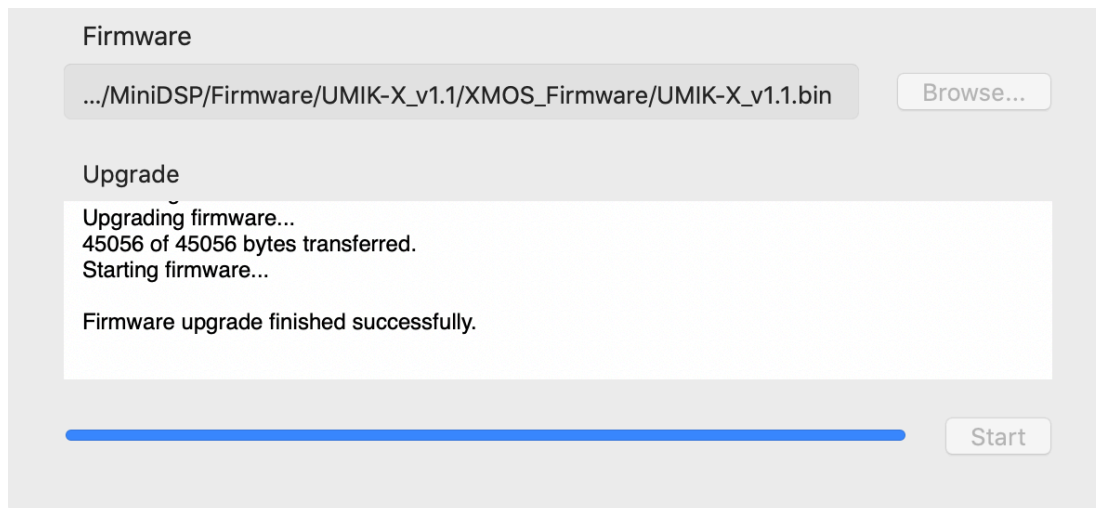

- Click on **Exit**.
- That's it! You're done. You can now use your UMIK-X again.



### 6.3 OBTAINING SUPPORT

1. Check the forums on [minidsp.com](http://minidsp.com) to see if this issue has already been raised and a solution or solutions provided.
2. Contact miniDSP via the support portal at [support.minidsp.com](http://support.minidsp.com) with:
  - a. The product information.
  - b. A clear explanation of the symptoms you are seeing.
  - c. A description of the troubleshooting steps you performed and the results obtained.